



**Value doors<sup>®</sup>**  
& windows

# Slimline Bi-fold doors



# The Finer Details

Our BF73 slimline aluminium bi-folding doors are designed and built- with the very latest technology. Our expertise has ensured that you do not need to compromise on energy efficiency, security or durability to have the very best bi-folding door for your home.

Our slimline frame profile guarantees the maximum sightline and volume of natural light into your home, whilst our PAS 24 approved locking system gives the highest level of security. Our market-leading available sash size, provides a solution to even the widest of openings.

- Maximum vision – minimal sight lines, only 120mm
- Maximum security – PAS 24 approved system
- Maximum insulation value – down to 1.4 U W/m<sup>2</sup>K
- Maximum weather proofing – BS6375 Part 1: 2009
- Single or dual colour – White RAL9016, Black RAL9005 or Anthracite Grey RAL7016
- Market leading sash size of 1200mm up to 3000mm high and 1200mm wide

## SPECIFICATION AT A GLANCE

- 120kg per door leaf – providing for the largest openings Panels of up to 3000mm high and up to 1200mm wide, without having to upgrade rolling hardware
- Above-ground bottom rollers
- Engineering grade running rollers for a smooth and silky opening and closing operation
- Thermal properties of down to 1.4 U W/m<sup>2</sup>K
- Sightline 120mm or 133mm for maximum vision PAS 24 approved system
- Tested to BS6375 Part 1 : 2009

## TABLE OF DIMENSIONS

Frame width	73mm
Frame depth	81mm inside to outside
Mullion sight line	120mm or 133mm
Glass possibilities	28mm, 32mm, 35mm, 44mm, double & triple glazed units
Max overall height	3000mm
Max overall width	16.8m

## TECHNICAL PERFORMANCE

Thermal properties	Down to 1.4 U W/m <sup>2</sup> K
Air Wind Water	Class C4, 600Pa
	Class A3, 1200Pa
	Class 9A, 600Pa



# Cross sections

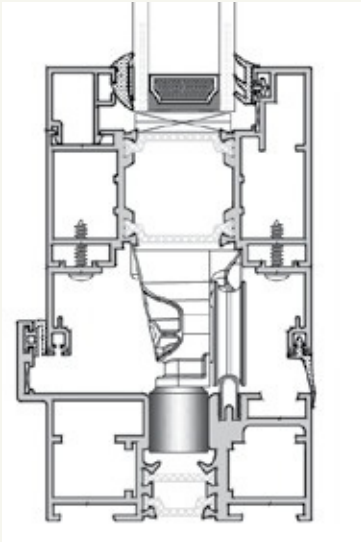

Standard threshold detail

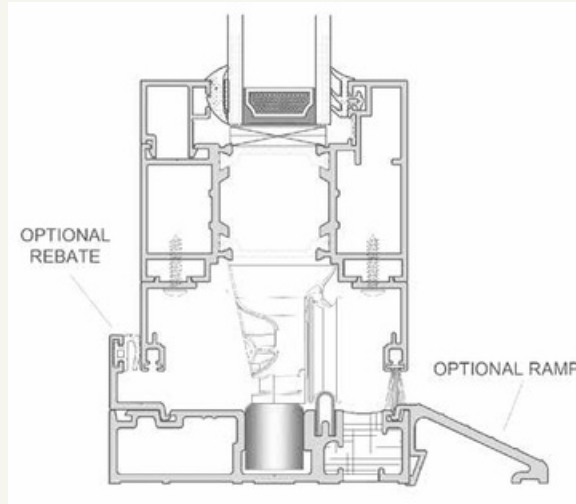

Low threshold detail

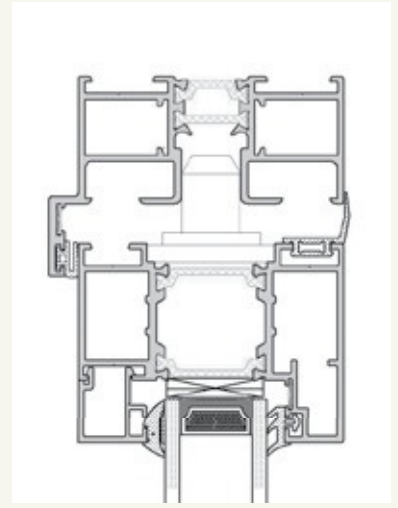

Head detail

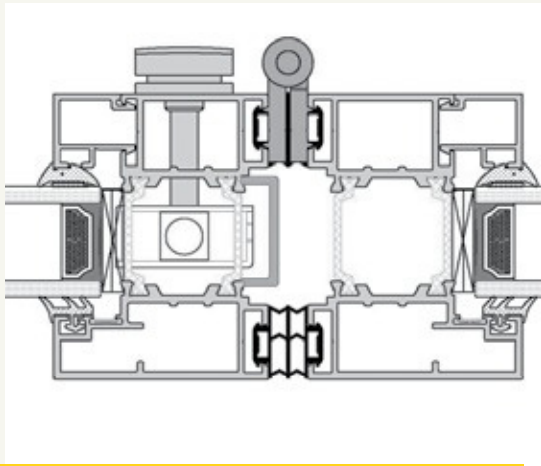

Intermediate detail integrated lock

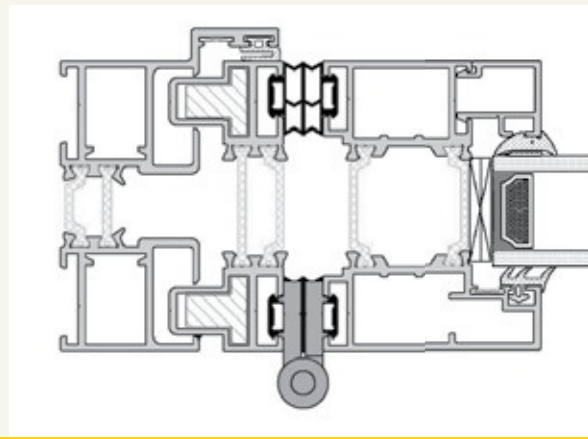

Outer frame detail with adjustable jamba



## OPTIONS



Finish Single or dual colour. Factory powder coated to marine quality as defined by Qualicote regulations.



Hardware Handles are available in 5 different types of finish, hinges are finished in black as standard.





Threshold Low threshold option to eliminate trip hazards.





Trickle Vent Available as an option.





# Bifolding Door





Total number of panels folding inside.

1 inside  110-IN  101-IN

2 inside  220-IN  202-IN  211-IN

3 inside  330-IN  303-IN  321-IN  312-IN

4 inside  440-IN  404-IN  431-IN  413-IN  422-IN



5 inside  550-IN  505-IN  541-IN  514-IN  532-IN

inside  523-IN

6 inside  660-IN  606-IN  651-IN  615-IN  642-IN



inside  624-IN  633-IN

7 inside  770-IN  707-IN  761-IN  716-IN  752-IN



inside  725-IN  743-IN  734-IN

8 inside  871-IN  817-IN  862-IN  826-IN

inside  853-IN  835-IN  844-IN

9 inside  972-IN  927-IN  963-IN  936-IN



inside  954-IN  945-IN



10 inside  1073-IN  1037-IN  1064-IN

inside  1046-IN  1055-IN

11 inside  1174-IN  1147-IN  1165-IN

inside  1156-IN

12 inside  1275-IN  1257-IN  1266-IN

13 inside  1376-IN  1367-IN

14 inside  1477-IN





[WWW.VALUEDOORS.CO.UK](http://WWW.VALUEDOORS.CO.UK) | PHONE 020 4587 8300